



Quick Installation Guide

For Network Attached Storage

Table of Contents

Notices.....	3
Safety Precautions	4
1. Package Contents.....	5
2. Optional Accessories.....	6
3. Hardware Installation Guide	7
3.1. Hard Disk Installation	7
3.2. Connecting and Powering on the NAS	9
4. Software Installation Guide	10
4.1. CD Installation	10
4.1.1. Windows Users	10
4.1.2. Mac Users	11
4.2. Web Installation.....	12
4.3. Installation Using a Direct Connection	12
5. Appendix.....	13
5.1. LED Indicators	13
5.2. Rear Panel	14
5.3. Rating Label.....	14
5.4. Troubleshooting	14

Notices

Federal Communications Commission Statement



This device complies with FCC Rules Part 15. Operation is subject to the following two conditions:

- This device may not cause harmful interference.
- This device must accept any interference received, including interference that may cause undesired operation.

This equipment has been tested and found to comply with the limits for a class B digital device, pursuant to Part 15 of the Federal Communications Commission (FCC) rules. These limits are designed to provide reasonable protection against harmful interference in a residential installation. This equipment generates, uses, and can radiate radio frequency energy and, if not installed and used in accordance with the instructions, may cause harmful interference to radio communications. However, there is no guarantee that interference will not occur in a particular installation. If this equipment does cause harmful interference to radio or television reception, which can be determined by turning the equipment off and on, the user is encouraged to try to correct the interference by one or more of the following measures:

- Reorient or relocate the receiving antenna.
- Increase the separation between the equipment and receiver.
- Connect the equipment into an outlet on a circuit different from that to which the receiver is connected.
- Consult the dealer or an experienced radio/TV technician for help.

Changes or modifications not expressly approved by the party responsible for compliance could void the user's authority to operate the equipment.

CE Mark Warning



CE marking for devices without wireless LAN/Bluetooth

The shipped version of this device complies with the requirements of the EEC directives 2004/108/EC "Electromagnetic compatibility" and IEC60950-1:2005 (2nd Edition)+A1:2009 "Information technology equipment-Safety".

Safety Precautions

The following safety precautions will increase the life of the NAS. Follow all precautions and instructions.

Electrical safety

- Unplug this product from the power source before cleaning.
- Use only the bundled power adapter. Using other power adapters may damage your device.
- Ensure that you plug the power adapter to the correct power input rating. Check the label on the power adapter for the power rating.

Operation safety

- DO NOT place this product in a location where it may get wet.
- Place this product on a flat and stable surface.
- Use this product in environments with an ambient temperature between 5°C and 35°C.
- DO NOT block the air vents on the case of this product. Always provide proper ventilation for this product.
- DO NOT insert any object or spill liquid into the air vents. If you encounter technical problems with this product, contact a qualified service technician or your retailer. DO NOT attempt to repair this product yourself.











DO NOT throw this product in municipal waste. This product has been designed to enable proper reuse of parts and recycling. This symbol of the crossed out wheeled bin indicates that the product (electrical and electronic equipment) should not be placed in municipal waste. Check local regulations for disposal of electronic products.



1. Package Contents

Applicable Models: AS-202T, AS-204T, AS-202TE and AS-204TE

Contents	AS-202T/AS-202TE	AS-204T/AS-204TE
NAS device		
Power cord		
	1	1
Adapter		
	1	N/A
RJ45 network cable		
	1	1
Screws for use with 3.5" HDD		
	8	16
Screws for use with 2.5" HDD		
	8	16
Installation CD		
	1	1
Quick Start Guide		
	1	1

2. Optional Accessories

The items below may be purchased from the ASUSTOR Accessories Store (<http://shop.asustor.com>). Other items such as HDMI cables (2M recommended), wireless RF keyboards, mice and remote controls along with Bluetooth keyboards and mice are purchased separately.

AS-RC10	AS-RAM1G	AS-RAM2G
 10 Key IR Remote Control	 1GB DDR3-1333 204Pin SO-DIMM RAM Module	 2GB DDR3-1333 204Pin SO-DIMM RAM Module
AS-250W	AS-150W	AS-60W
 250W Flex Power Supply	 150W Flex Power Supply	 60W Power Adaptor
AS-Tray	AS-Rail	AS-IR
 Black HDD tray for 2.5 & 3.5-inch HDD	 Rail kit for 1U/2U Rack-Mounted System	 USB IR Receiver for AS-6
AS-RCU		
 IR Remote Control with USB IR Receiver for AS-6		

3. Hardware Installation Guide

All data stored on the hard disk(s) will be erased and CANNOT be recovered. Please back up all important data before initializing the system.

3.1. Hard Disk Installation

- Press the button on the lower portion of the hard disk tray to release the latch.

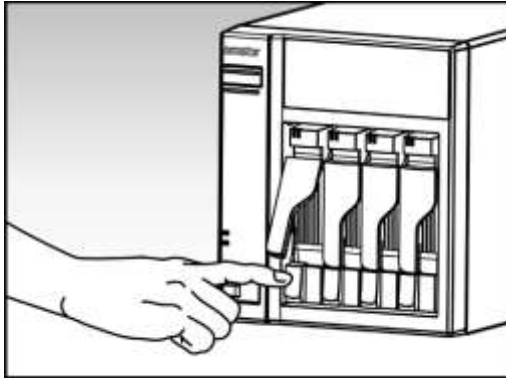

- Using the latch, gently pull the disk tray out of the disk bay.

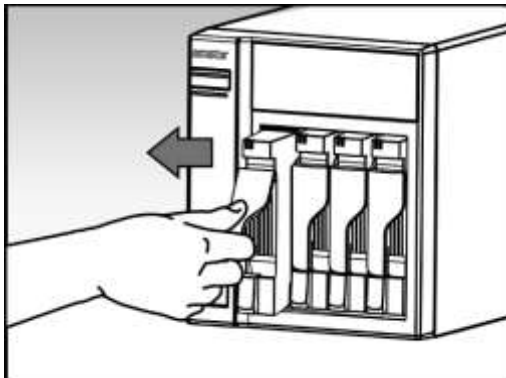

- Mount the hard disk to the disk tray
 - **3.5-inch hard disks:** Place the hard disk into the disk tray, making sure that the mounting holes on the sides of the hard disk and disk tray are lined up. Secure the drive with four screws.

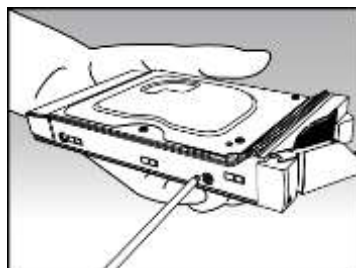

- **2.5-inch hard disks and SSD hard disks:** Place the hard disk into the area of the disk tray outlined in red (see picture below). Make sure that the mounting holes on the bottom of the hard disk and disk tray are lined up. Secure the drive with four screws.

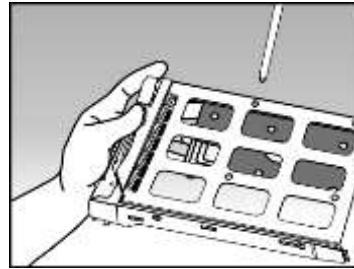
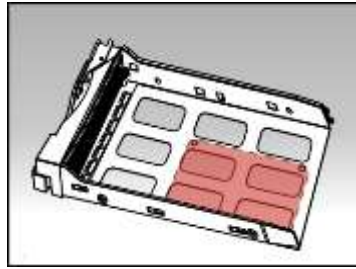

- Slide the disk tray onto the rails of the disk bay. Using the latch, gently push the disk tray all the way into the disk bay. Secure the disk tray in place by pushing down on the latch. The latch should close easily and snap in with an audible 'click'. Please make sure that the disk tray is pushed all the way into the disk bay before attempting to secure the latch.

Note: If you are only installing one hard disk, please make sure to install it in the first disk bay (the disk bay furthest to the left).

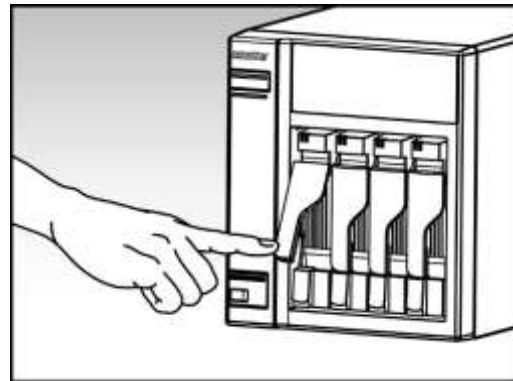
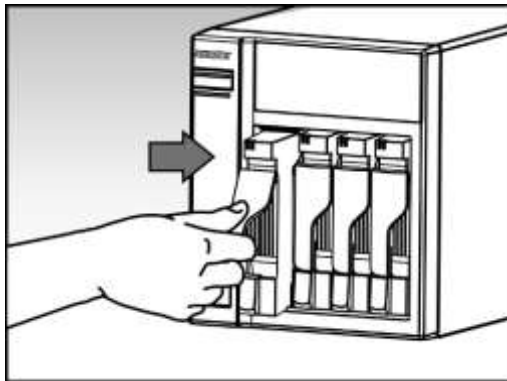

3.2. Connecting and Powering on the NAS

- Connect the NAS to its power supply.
- Connect the NAS to your router, switch or hub using an Ethernet cable.

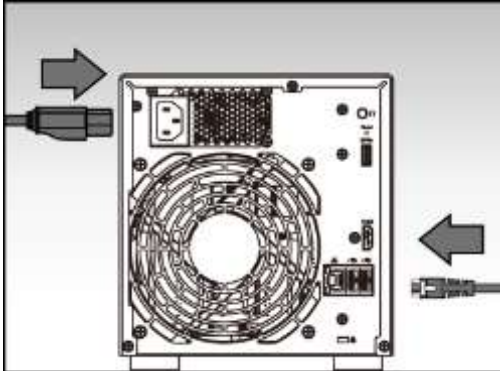

- Press and hold down the power button for 1 – 2 seconds until the blue power LED indicator is lit. This indicates that the NAS is now powered on. While the NAS is being powered on, the green system status LED indicator will flash and the blue network LED indicator will be lit as well.

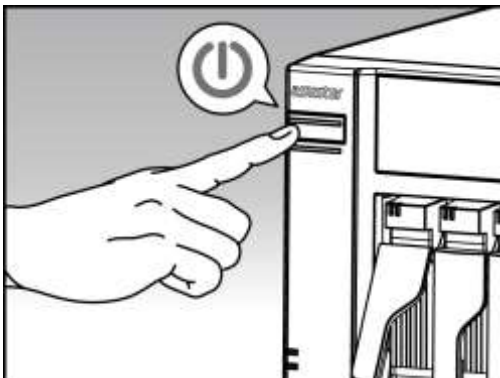

- The NAS is ready for operation once the green system status LED indicator has stopped flashing and remains steadily lit. At this time, you should also hear a 'beep' from the system buzzer. Hardware installation is now complete. Please move on to the software installation guide to configure your system settings.

4. Software Installation Guide

There are 3 different installation methods that you can choose from.

Note: Before you begin installation, please make sure that you have the latest version of the ADM software prepared. You can obtain the ADM software from the installation CD or from the ASUSTOR website: <http://www.asustor.com/service/downloads>.

4.1. CD Installation

4.1.1. Windows Users

- Insert the installation CD into your computer's CD drive and then select "Start" from the autorun CD-menu.



- The installation wizard will install ASUSTOR Control Center onto your computer. After ASUSTOR Control Center has been installed, it will automatically begin to scan your network for ASUSTOR NAS devices.
- Select your NAS from the list and follow the installation wizard's instructions to complete the configuration process.



4.1.2. Mac Users

- Insert the installation CD into your computer's CD drive and then select "Quick Install" from the autorun CD-menu.

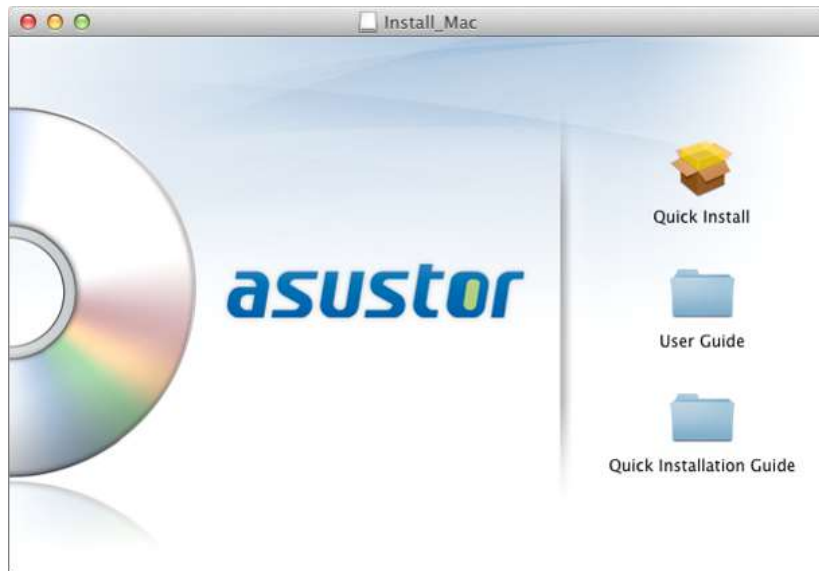

- The installation wizard will install ASUSTOR Control Center onto your computer. At this time you can also choose whether or not you want to install Download Assistant. After ASUSTOR Control Center has been installed, it will automatically begin to scan your network for ASUSTOR NAS devices.
- Select your NAS from the list and follow the installation wizard's instructions to complete the configuration process.

4.2. Web Installation

- If you already know your NAS's current IP address, you can open up a web browser and enter in your NAS's IP address (for example: <http://192.168.1.168:8000>) to begin initialization.
- Please follow the instructions from the installation wizard to complete the configuration process.



4.3. Installation Using a Direct Connection

Please see section [5.4 Troubleshooting](#) for installation instructions.

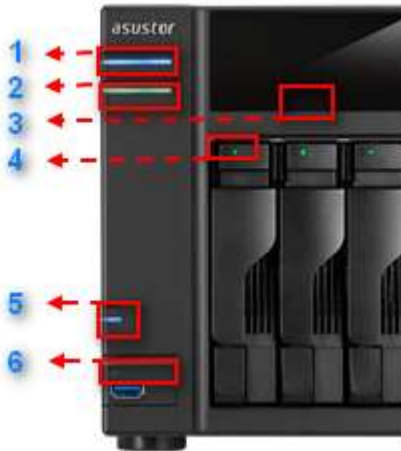

5. Appendix

5.1. LED Indicators



1. Power LED Indicator
2. System Status LED Indicator
3. Infrared Receiver*
4. Hard Disk LED Indicator
5. Network LED Indicator
6. USB LED Indicator

*Not supported on AS-202T and AS-204T.

LED Indicator	Color	Description	State
Power	Blue	Steadily lit	Power on
		Flashing	Waking from sleep mode (S3)
	Orange	Steadily lit	Sleep mode (S3)
		Flashes every 10 seconds	LED night mode
System Status 	Green	Flashing	Powering on
		Steadily lit	System ready
Network 	Blue	Steadily lit	Network port connected
USB 	Green	Steadily lit	The USB device connected to the front of the NAS is ready for use
		Flashing	Data access in progress
Hard Disk	Green	Steadily lit	Hard disk ready
		Flashing	Data access in progress
	Red	Steadily lit	Hard disk abnormality

5.2. Rear Panel

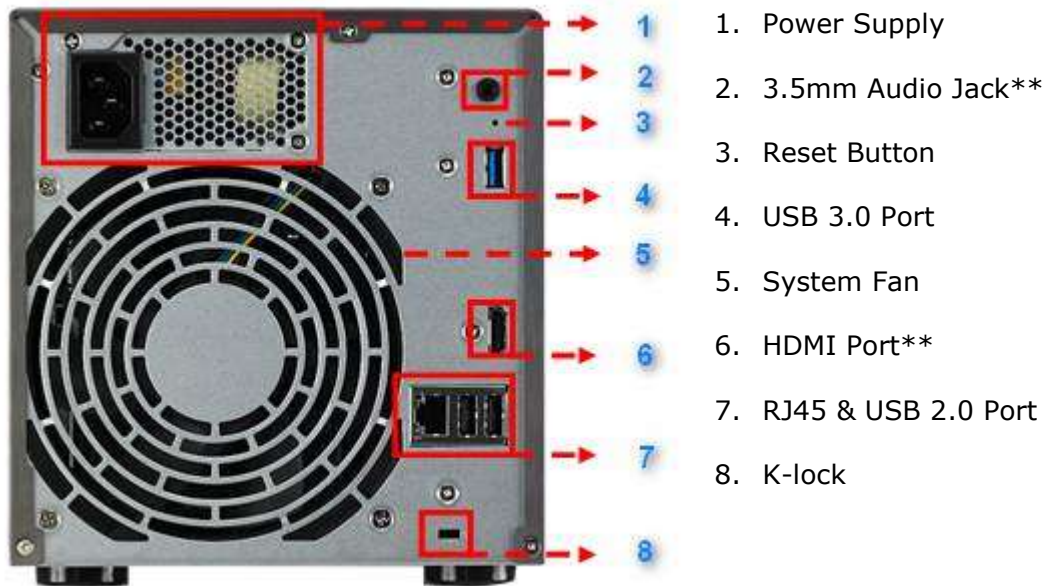

**Not supported on AS-202T and AS-204T.

5.3. Rating Label

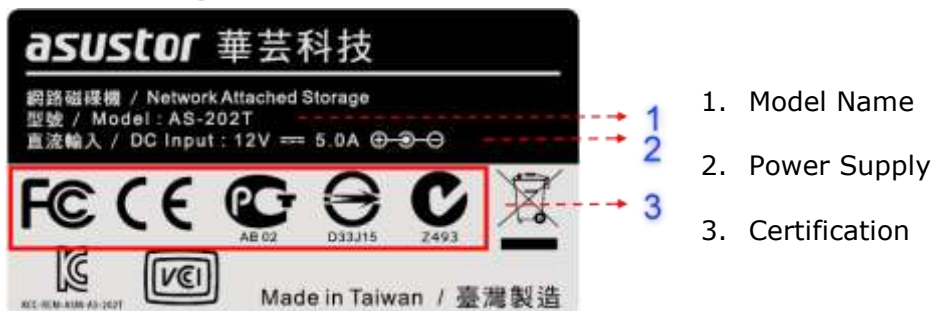

5.4. Troubleshooting

Q: Why can't I detect my ASUSTOR NAS using ASUSTOR Control Center?

A: If you are having trouble detecting your NAS using ASUSTOR Control Center, please do the following:

1. Please check your network connection:
 - a. Make sure that your computer and your NAS are part of the same local area network.
 - b. Check to see if the network LED indicator is lit. If you find that it is not lit, try connecting your Ethernet cable to the other network port or try using a different Ethernet cable.
2. Please first disable any firewalls that may be running on your computer. Then try scanning for your NAS again using ASUSTOR Control Center.
3. If you still cannot detect your NAS, please connect your NAS to your computer using the provided RJ-45 network cable and change your computer's IP settings.

- a. Select **[Start]->[Control Panel]->[Network and Sharing Center]**

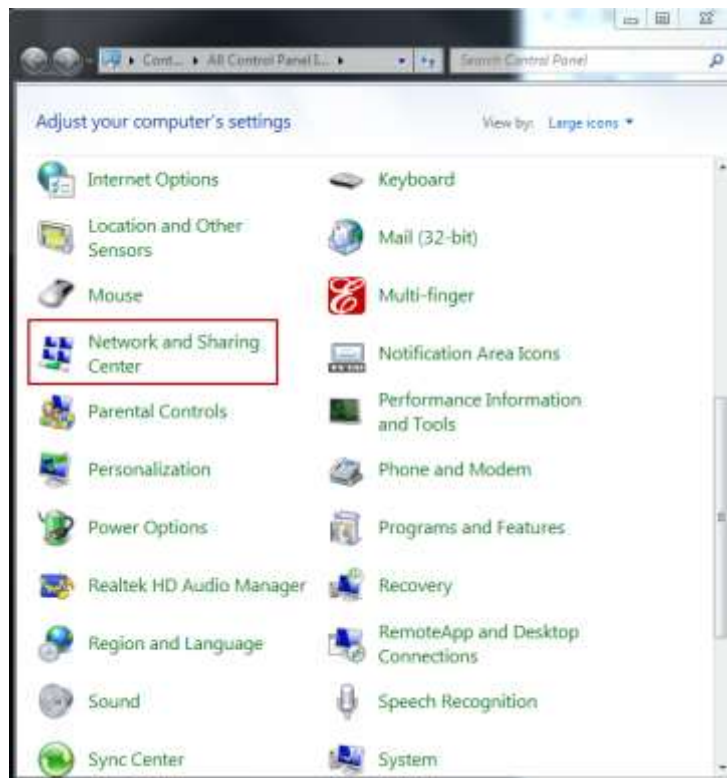

- b. Click on **[Change adapter settings]** in the left hand panel.

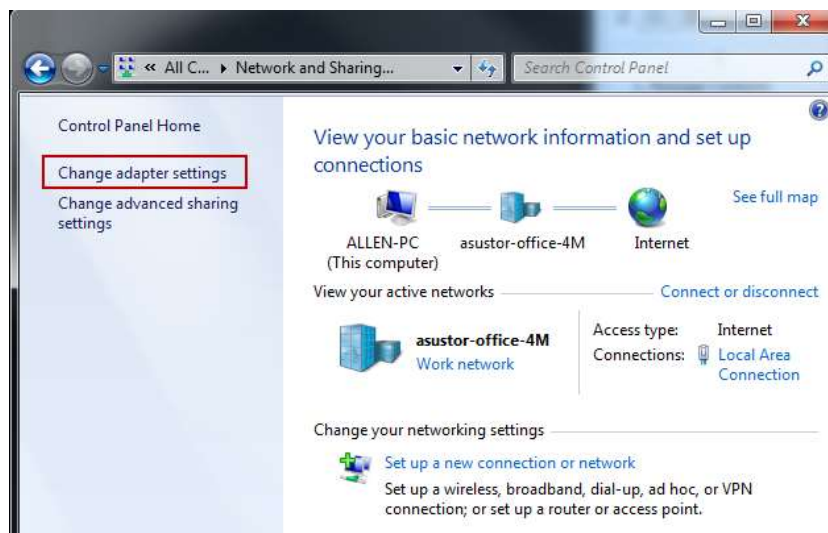

- c. Right-click on **[Local Area Connection]** and select **[Properties]**.

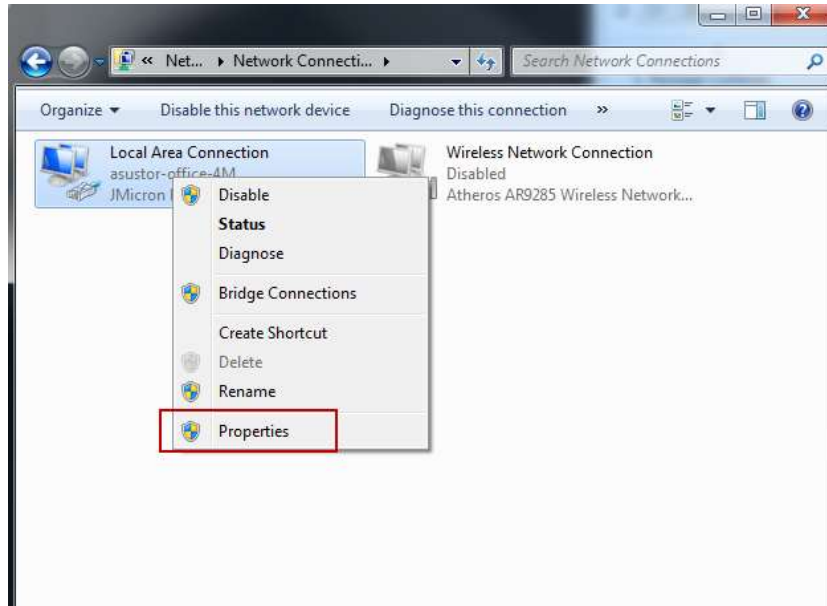

- d. Under the **[Networking]** tab select **[Internet Protocol Version 4 (TCP/IPv4)]** and click on **[Properties]**.

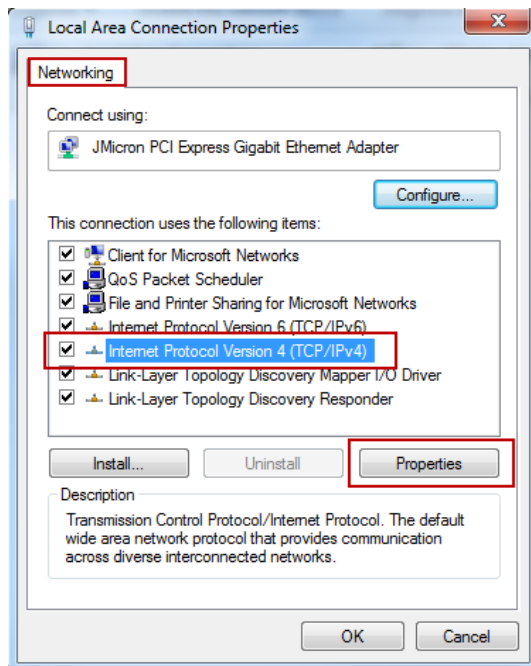

- e. Under the **[General]** tab select the **[Use the following IP address]** radio button. Set the **[IP address]** to **169.254.1.1** and the **[Subnet mask]** to **255.255.0.0** and then click on **[OK]**.

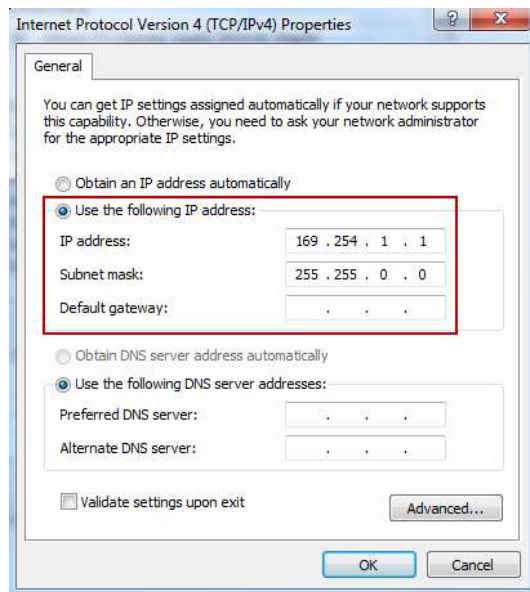

- f. Open up ASUSTOR Control Center to scan for your NAS.
4. If the above mentioned procedures have not managed to solve your problem, please contact your local ASUSTOR dealer or ASUSTOR Customer Service. You are also encouraged to browse through the [ASUSTOR Knowledgebase](#).